

SWING MOUNT ADAPTER

Installation Instructions



Table of Contents	Page
Adapter Installation Notes	2
4492 Belmont X-Calibur and Healthco Celebrity	3
4491 Marus and DCIE	4
4489 Pelton & Crane and A-dec® Cascade®	5
4498 A-dec® Priority® 1005	6
9246 A-dec® Decade®	7

ADAPTER INSTALLATION NOTES

BEFORE YOU BEGIN

- Review the unit overview in this manual and layout dimensions. Ensure that the planned location will have the necessary space available for installation, including the travel of the chair base and the backrest.
- Open all containers and review the contents. It may be helpful to locate all kits containing components and accessories for installation.
- Locate all documentation supplied with the equipment. Manuals and installation information may be found in one or more boxes with their respective components. Set aside the documentation for the end user to review.

SYMBOLS USED IN THIS MANUAL

The following symbols may be used throughout this product manual:



CAUTION: Failure to carefully follow the described procedure may result in damage to the equipment.



WARNING: Failure to carefully follow the described procedure may result in damage to the equipment or the operator.

SPECIAL TEXT FORMATTING

To simplify installation, this manual is formatted to highlight references for necessary parts or tools:

- Parts that need to be located during assembly are shown in **bold**.
- Tools that are required for each step are shown underlined.

SUGGESTED TOOLS

- 7/16" combination wrench
- 9/16" combination wrench or deep wall socket
- 5/8" combination wrench
- 15/16" combination wrench
- SAE hex key set (some hex keys will be included with equipment)
- Magnetic Level, 6 to 12 inches long
- Scissors or utility knife
- Flathead screwdriver, small
- Phillips screwdriver, small

4492 BELMONT X-CALIBUR AND HEALTHCO CELEBRITY

Kit Includes:

- Adapter Plate Qty. 1
- M12-1.75 x 45mm Patch Lock
- Zinc Screws Qty. 3
- 1/2" Zinc Washers Qty. 3
- Foot Rest Support Bar Qty. 1
- 3/8-16 x 1.25L Flanged Screws Qty. 4

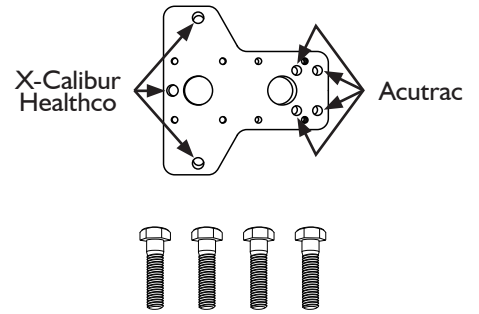
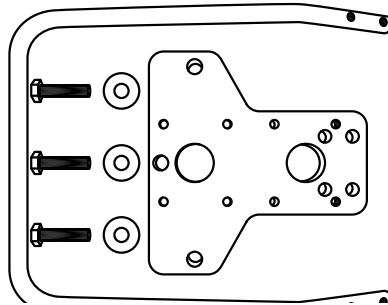

NOTE: Refer to Installation Instructions for Swing Mount System for flanged screw installation.

1. Remove the seat plate assembly from the chair as per manufacturer instructions.
2. With a Phillips screwdriver, remove and discard the existing Foot Rest Support Bar from the chair casting. **Do Not Discard the Screws**, they will be reused.

Foot Rest Support Bar and Chair Casting

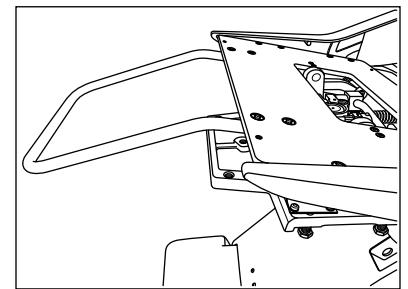

3. Install the **Adapter Plate** to the bottom of the chair's rotation flange with the three **M12-1.75 x 45mm screws and 1/2" washers**. Tighten the screws to 50 ft. lbs. of torque.

Adapter Plate to the Bottom of the Rotation Flange

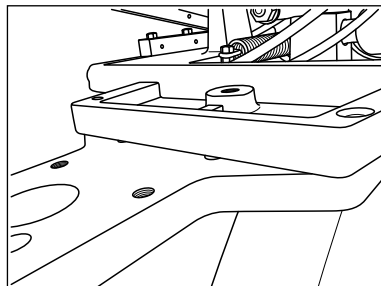

Screws and Washers Installed with 50lbs of Torque

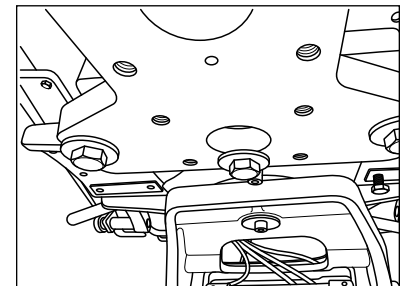

4. Install the "New" **Foot Rest Support Bar** to the bottom of the chair casting with the existing screws (from Step #2) and a Phillips screwdriver.

Foot Rest Support Bar to the Bottom of the Seat Plate

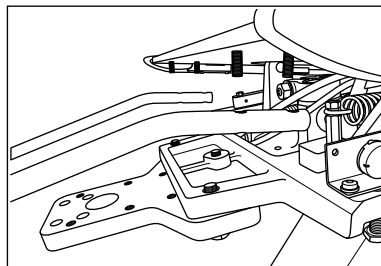

Foot Rest Support Bar Adapter Plate Installation Complete

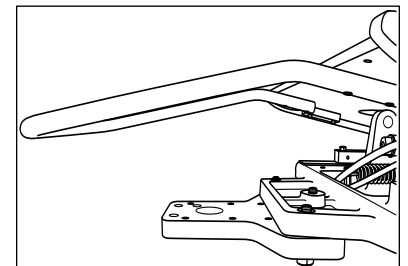

5. Re-install the seat plate assembly as per chair manufacturer instructions.

449I MARUS AND DCIE

Kit Includes:

- Adapter Plate Qty. 1
- 3/8-16 x 1.50 Zinc Screws Qty. 4
- 3/8 Split Lock Washers Qty. 4
- 3/8-16 x 1.25L Flanged Screws Qty. 4

NOTE: Refer to Installation Instructions for Swing Mount System for flanged screw installation.

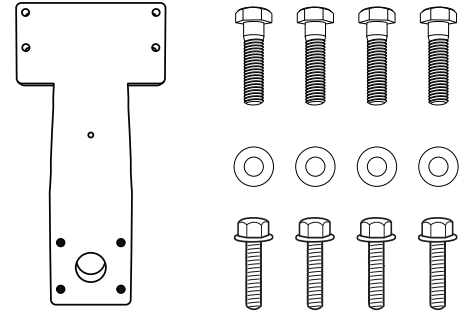

To avoid injury, have an assistant hold up the seat assembly during bearing block and adapter installation.

1. Recline the seat back, then lift the toe board and roller assembly.
2. Install the **Adapter Plate** to the bottom of the chair casting with the four **3/8 screws, lock washers** and a 9/16" socket (deep wall or 3" adapter). Tighten the screws to 50 ft. lbs. of torque.

Insert screws with washers into the Adapter Plate through the top of the Chair Chassis

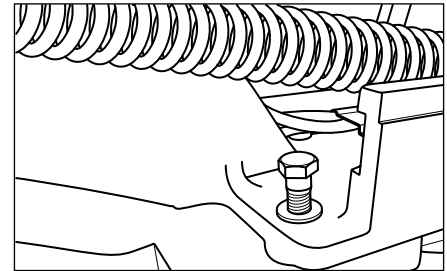

Tighten all four screws to 50lbs of torque.

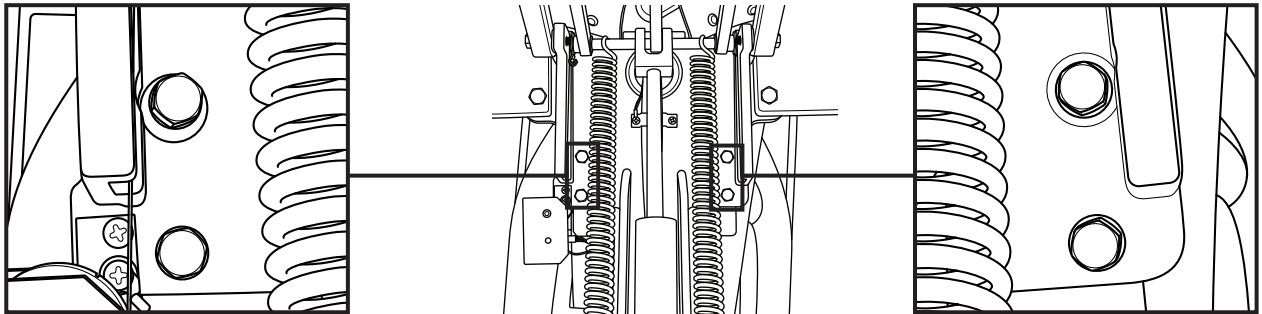

Installation Complete

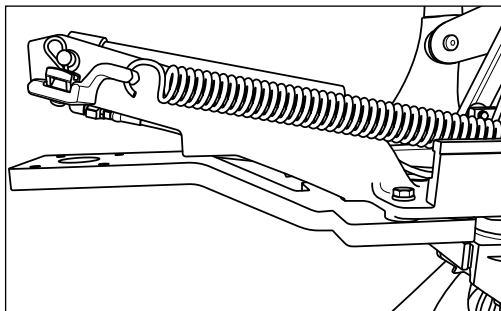

4489 PELTON & CRANE AND A-DEC® CASCADE®

Kit Includes:

- Adapter Plate Qty. 1
- Tightener Plate Qty. 1
- 5/8-11 Nylock Nut Qty. 2
- 5/8 Flat Washer Qty. 2
- .625-11 x 2.25 Zinc Screw Qty. 1
- .625-11 x 1.75 Black Set Screw Qty. 1
- 3/8-16 x 1.25L Flanged Screws Qty. 4

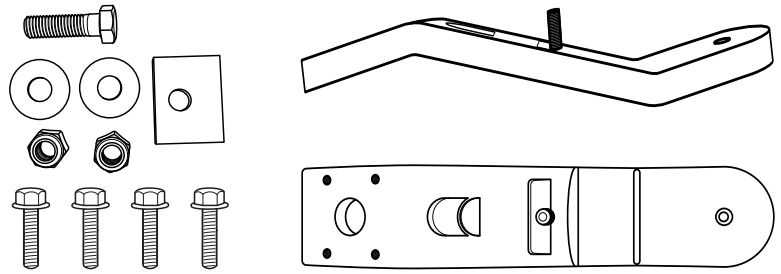

NOTE: Refer to Installation Instructions for Swing Mount System for flanged screw installation.



To avoid injury, have an assistant hold up the seat assembly during adapter installation.

1. Recline the seat back, then lift the toe board and roller assembly.
2. Attach the **Adapter Plate** to the bottom of the chair casting. Install **.625-11 x 2.25 screw** with **5/8 washer** through the adapter plate and up into the chair casting.
3. Install **5/8 washer and 5/8 nylock nut** onto screw in the center of seat structure. Tighten the screw and nut with two 15/16" wrenches.
4. Install the **Tightener Plate** onto the threaded stud in adapter plate with the **5/8 nylock nut**. Center the adapter plate to the front of the chair casting then secure tightener plate using a 15/16" wrench.

Position the adapter plate underneath the chair seat structure

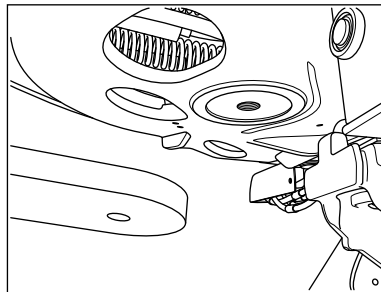

Screw and washer through adapter plate and chair casting.

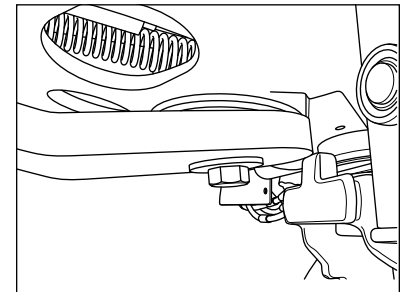

Tighten with two 15/16" wrenches.

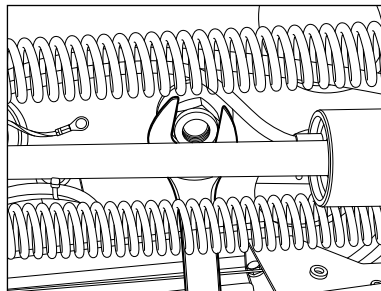

Tighten with two 15/16" wrenches.

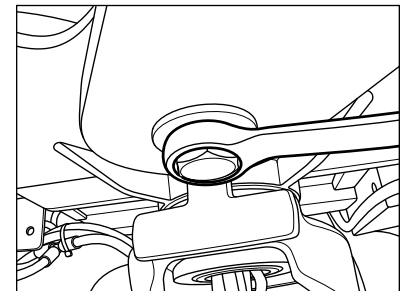

Tightener Plate

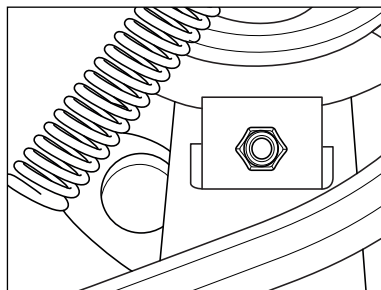

Installation complete.

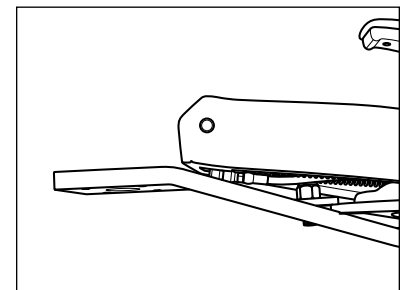

4498 A-DEC® PRIORITY® I005

Kit Includes:

- Adapter Plate Qty. 1
- 1/4-20 x 1.5 Screw Qty. 2
- 1/4 Flat Washer Qty. 2
- Bearing Block Assembly Qty. 1
- 3/4 Lock Washer Qty. 1
- 3/4-10 x 2 Screw Qty. 1
- 3/8-16 x 1.25L Flanged Screws Qty. 4

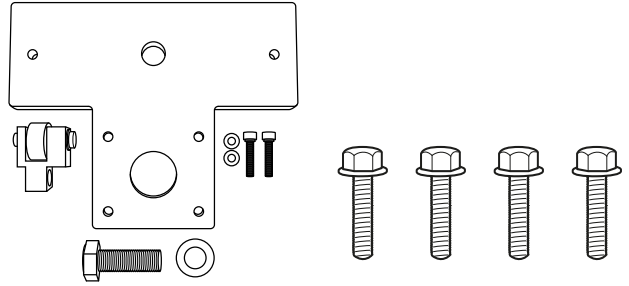

NOTE: Refer to Installation Instructions for Swing Mount System for flanged screw installation.

 To avoid injury, have an assistant hold up the seat assembly during bearing block and adapter installation.

1. Recline the seat back and lift the toe board assembly.
2. Remove the existing bearing from the roller assembly, **Do Not Discard the Existing “E” Clip And Washer**, then install the Bearing Block Assembly to the roller assembly.

Remove Existing Bearing

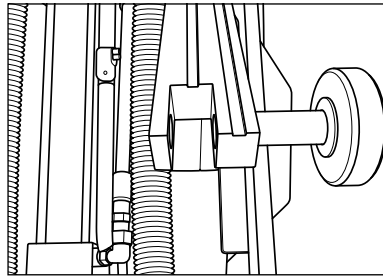

Install Bearing Block Assembly

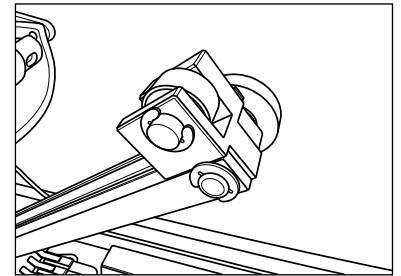

3. Install the **Adapter Plate** to the top of the chair casting with the two (1/4-20 x 1.5 screws and 1/4 flat washers). Next install the 3/4 lock washer and the 3/4 screw and tighten to 50 ft. lbs. of torque to secure the plate to the chair.

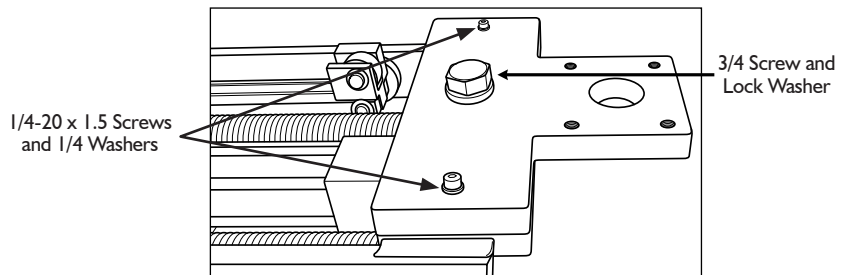

4. Remove the truss cover and lower the chair until the bottom of **Adapter Plate** is 5½” from the top of the pump cover. Look inside the truss and locate the limit switches. With a 3/8 nut driver, loosen the nut above the switch on the right. Slide switch into the post until the switch engages (“clicks”); tighten the nut to secure the switch in place.

Lower chair to within 5½ in of pump cover.

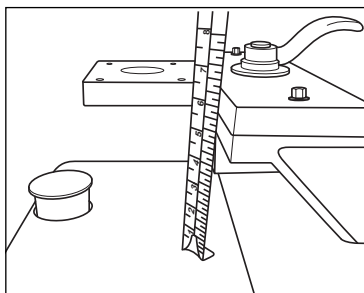

Limit switches inside of truss.

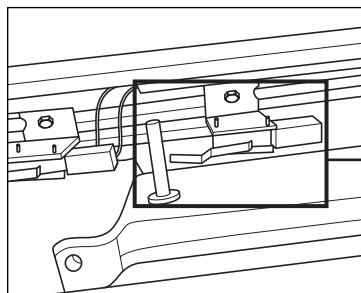

Slide right side switch into post to set lower limit.

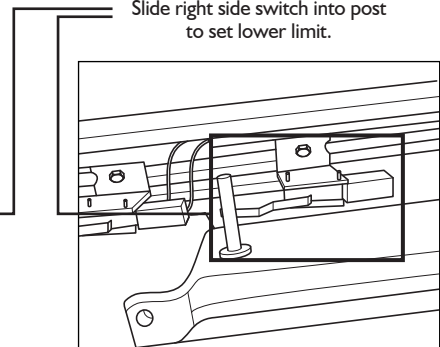

5. Raise and lower the chair. Double check the measurement between the **Adapter Plate** and the pump cover. Replace the truss cover.

9246 A-DEC® DECADE®

Kit Includes:

- Adapter Plate Qty. 1
- 3/8-16 x 1.25L Flanged Screws Qty. 4
- 5/8-11 x 1.5L Bolt Qty. 2
- 5/8-18 Zinc Nylock Nut Qty. 1
- 5/8 Zinc Lock Washer Qty. 2
- 5/8 Zinc Flat Washer Qty. 3

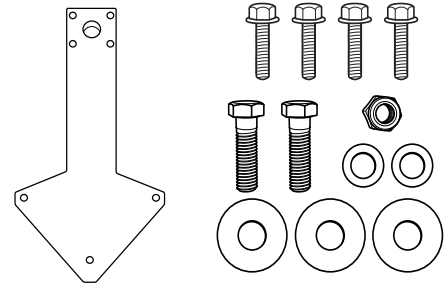

NOTE: Refer to Installation Instructions for Swing Mount System for flanged screw installation.



To Avoid Injury, Have an Assistant Hold Up the Seat Assembly During Adapter Installation.

1. Recline the seat back, then lift the toe board and roller assembly.
2. Attach the **Adapter Plate** to the existing stud in the bottom of the chair casting. Hold the adapter in place with a **Flat Washer, Lock Washer and a Nylock Nut** as shown. Do not tighten at this time.

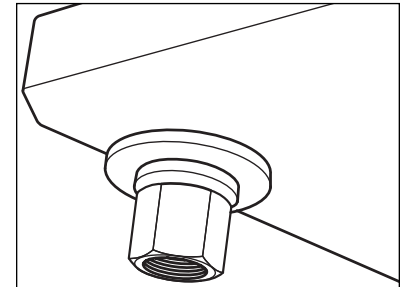
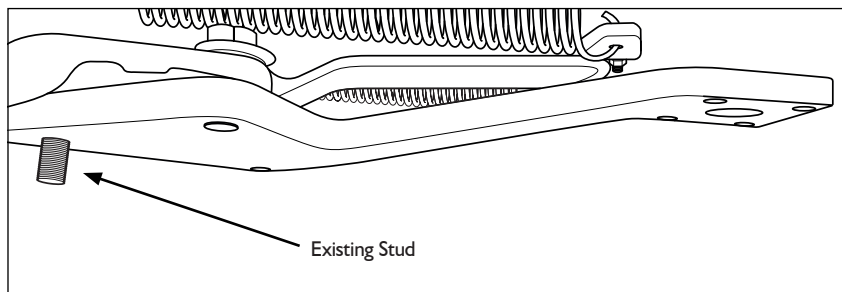

3. Install the two **5/8 Bolts** with **Flat Washers** into the adapter through the top of the chair casting as shown.

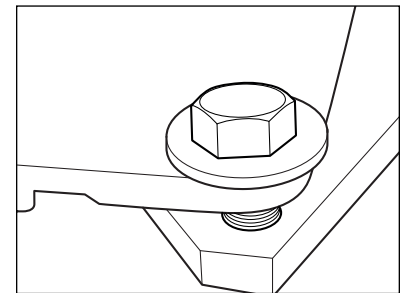
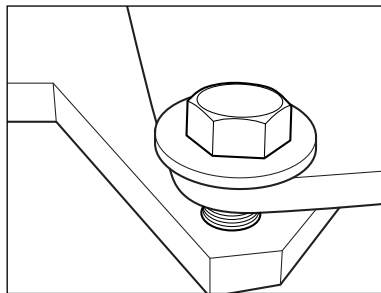

4. Complete the adapter installation by tightening the nylock nut and two 5/8 bolts with a 15/16" wrench or socket to 50 ft. lbs. of torque.

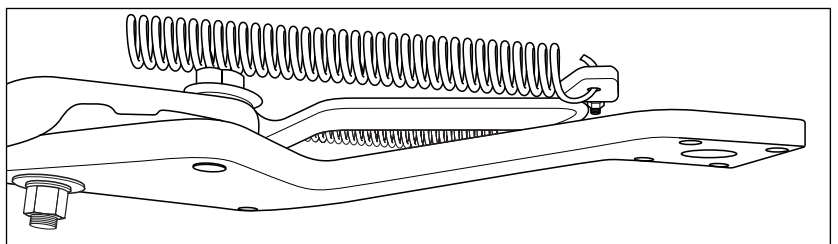

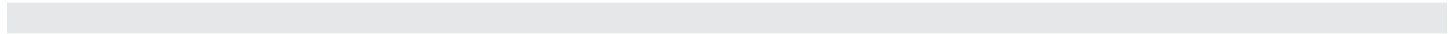

A-dec®, Cascade®, Priority® and Decade® are registered trademarks of A-dec, Inc. DCI has no affiliation with A-dec and A-dec has not authorized DCI replacement parts to be used on or in connection with A-dec® products.



PN 92482, Rev. J, 2022-12-06

www.dcionline.com
800-624-2793



DCI International, LLC
705 S. Springbrook Road Bldg C
Newberg, OR 97132, USA