

LED OPERATORY LIGHT

OVERVIEW

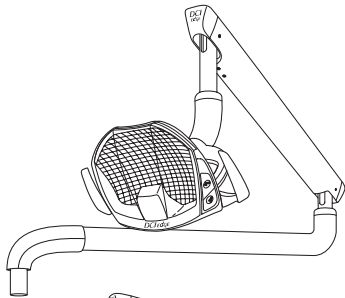

Post Mount Light
LP4000 / LP4050
LP5000 / LP5050

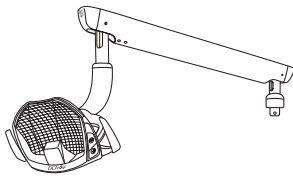

Adapted Post Mount Light
LP5052
LP5053
(Call for Availability)

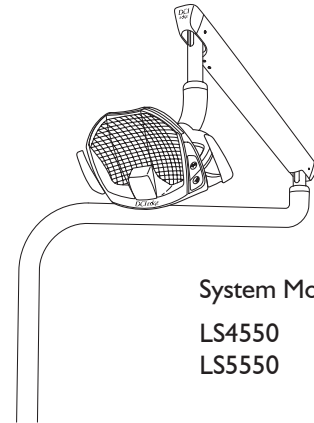

System Mount Light
LS4550
LS5550

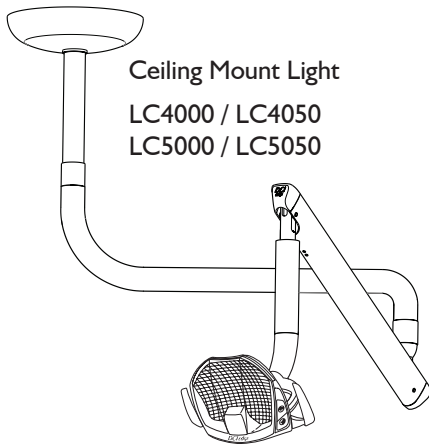

Ceiling Mount Light
LC4000 / LC4050
LC5000 / LC5050

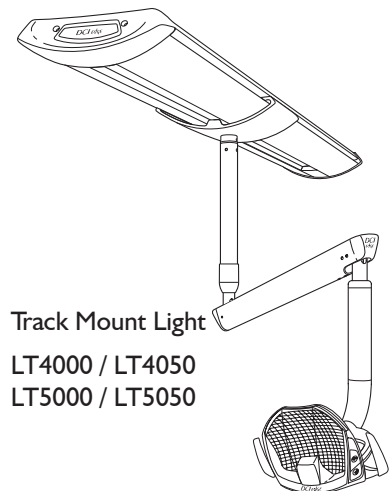

Track Mount Light
LT4000 / LT4050
LT5000 / LT5050

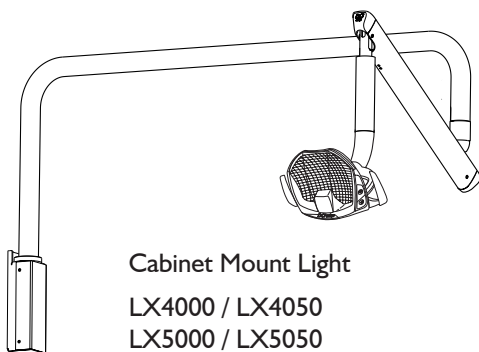

Cabinet Mount Light
LX4000 / LX4050
LX5000 / LX5050

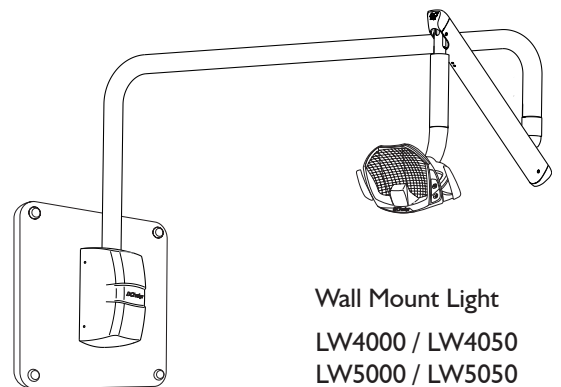

Wall Mount Light
LW4000 / LW4050
LW5000 / LW5050

INTRODUCTION

SYMBOLS

The following symbols may be used throughout this product manual:



















-  **WARNING:** Failure to carefully follow the described procedure may result in damage to the equipment, the the operatory, and/or the operator.
-  **CAUTION:** Failure to carefully follow the described procedure may result in damage to the equipment.
-  **NOTE:** Take note of additional important information. Not a warning or caution.
-  **ELECTRICAL HAZARD:** Risk of electrical shock present. Ensure that power is disconnected before attempting procedure.
-  Manufacturer
-  Manufacturing date
-  Type BF applied part
-  Waste Electrical and Electronic Equipment
-  Protective Earth (ground)
-  Alternating Current (AC)
-  **CE** Conforms to applicable European Directives (Essential Requirements)
-  **ETL** US Electrical Testing Lab
-  Advisable to consult accompanying documents
-  **MD** Medical device
-  **UDI** Unique Device Identifier
-  Power ON/OFF
-  No Cure
-  Dimming
-  Motion Sensor

TABLE OF CONTENTS

Overview	2
Introduction	3
General Information	4
General Safety	6
Operation - Series 4 Controls	7
Operation - Series 5 Controls	8
Operation - Range of Motion	9
Maintenance	10
Electromagnetic Compatibility	15

GENERAL INFORMATION

INTENDED APPLICATION AND USE

The DCI Dental LED operatory light is specifically designed for dental operatory rooms, providing focused and shadow-free illumination during procedures. Featuring adjustable positioning, color accuracy, infection control, and versatile mounting options, this device ensures enhanced visibility, contributing to an efficient working environment for dental professionals.

PRODUCT IDENTIFICATION

The DCI Edge LED operatory light can be identified by the label on the back side of the light head. This label states the model number, serial number, electrical specifications, manufacturing date, software version, and safety classifications.

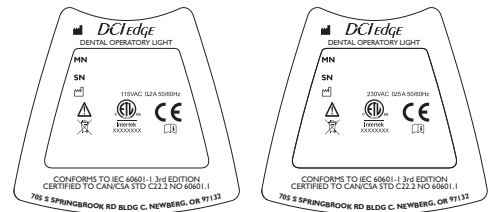

ELECTRICAL SPECIFICATIONS

115VAC	230VAC	Fuses are labeled at point of use. Replace fuses only with type and rating as indicated below. Fuses are used in model numbers starting with LP except for Adapted Post Mount Lights: Fuse type GTL, glass cartridge 5x20mm Voltage and Current ratings 250V Operating speed Slow burn fuse (time delay) Breaking capacity 1 Amp
0.2 Amps	0.15 Amps	
50-60Hz	50-60Hz	
IEC Medical Classification I		
Operation: Continuous		
Splash Protection: IPX0		

ENVIRONMENTAL CONDITIONS

Operating Conditions:
Temperature: 67-76° F
Humidity: 20-60%
Altitude: <5,000 m
Shipping conditions:
Temperature: -68 - 122° F
Humidity: 10-90%

ELECTRICAL DEVICE INTERFERENCE

To guarantee the operational safety of electromedical devices, it is recommended that the operation of mobile radio telephones in the medical practice or hospital be prohibited. Strong EMI sources such as electrosurgery units or x-ray units may affect performance. If performance problems occur, move the light to another electrical circuit or physical location.

INCOMPATIBLE DEVICES

For safety reason, only DCI original devices and accessories approved for this product or accessories from third parties released by DCI may be used.

TECHNICAL DOCUMENTATION

The manufacturer will make available upon request circuit diagrams, component part lists, descriptions, and calibration instructions to technical personnel responsible for the installation and service of this equipment.

PRODUCT DISPOSAL

Contact your local, authorized dealer for disposal of this device to ensure compliance with your local environmental regulations.

GENERAL INFORMATION

PREVENTATIVE INSPECTION

The performance of the equipment can be affected by use over time. Inspect joints and tensioning screws as a regular maintenance item to ensure proper positioning of the device. See Maintenance sections of this manual for detailed instructions.

PRE-USE REQUIREMENTS

All operators of this device must read this document in its entirety before use.

Ensure that all installation steps are completed by a trained technician as described in the Installation Instructions for this device.

Ensure all functions and features as defined in the Operation sections of this manual are operating properly.

Follow the instructions on cleaning and disinfecting in the **“Maintenance”** section of this manual before first time use of this device.

Ensure that all staff responsible for the maintenance, disinfection, and cleaning of this device are fully trained on the information provided in the **“Maintenance”** section of this manual.

GENERAL SAFETY

WARNINGS & CAUTIONS



WARNING: This product must be disinfected before use.



CAUTION: Only authorized service technicians should attempt to service this equipment. Use of other than authorized technicians will void the warranty.



CAUTION: Use a licensed electrician for all wiring.



ELECTRICAL HAZARD: To avoid risk of electric shock, this equipment must be connected only to supply mains with protective ground.



WARNING: Modification of this equipment is not allowed.



NOTE: To isolate Mains power, use the Mains supply breaker in the breaker box.



WARNING: Failure to disinfect this device between patients could expose the user and patient to cross contamination and bioburden/biocontamination.



WARNING: Power cords and their associated parts cannot be substituted without increased risk of shock or fire. Use authorized replacement parts only. Power cords must be installed by qualified personnel. Ensure all service loops, strain reliefs and cord guards are in place and that line, neutral and ground wires are secured.



WARNING: Do not face the light head reflector directly at the sun. Doing so may cause damage to the light head components.

OPERATION - SERIES 4 CONTROLS

NORMAL OPERATION

Keypads are located on both sides of the light head and are easily accessible while grasping the handle on either side.

POWER: Press the **Power** key to turn the light ON or OFF.

INTENSITY: Press the **Intensity** key to toggle between HIGH/MEDIUM/LOW settings.

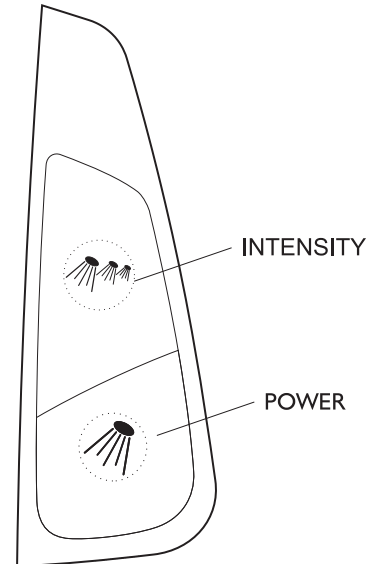

RIGHT KEYPAD
(LOCATED ON THE FRONT
OF THE LIGHT HEAD)

OPERATION - SERIES 5 CONTROLS

KEYPADS

Keypads are located on both sides of the light head and are easily accessible while grasping the handle on either side.

POWER: Press the **Power** key to turn the light ON or OFF.

INTENSITY: Press the **Intensity** key to toggle between HIGH/MEDIUM/LOW settings.

NO CURE: Press the **No Cure** key to toggle the light from No Cure to Normal mode.

MOTION SENSORS

The Series 5 light head is equipped with two programmable motion sensors which are factory set to operate the Dimming (right sensor) and No Cure (left sensor) functions of the light.

Operate the sensor by waving your hand approximately 2 inches in front of the sensor with a deliberate motion which does not cross over to the other sensor.



NOTE: Direct sunlight shining into the motion sensors may cause unintended activation or deactivation. If the sensor reacts to direct sunlight in this manner, lower shades or disable the motion sensor.

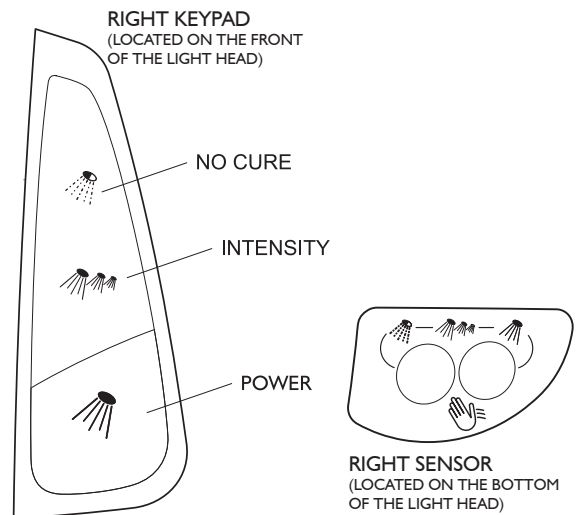

PROGRAMMING MOTION SENSORS

The motion sensors can be independently assigned any of the three keypad functions.

ASSIGN NEW FUNCTION TO EACH SENSOR

1. Ensure that the light is off.
2. To assign a function to the right side sensor: Using the right side keypad, press and hold any key for 5 seconds to assign the function of that key to the sensor.
3. Repeat the same process using the left side keypad to assign a function to the left side sensor.

REMOVE SENSOR ASSIGNMENT (DISABLE)

1. Ensure that the light is off.
2. To remove the assigned function from the right side sensor: Using the right side keypad, press and hold the No Cure and Intensity keys simultaneously for 5 seconds.
3. Repeat the same process using the left side keypad to remove the assigned function from the left side sensor.

OPERATION - RANGE OF MOTION

LIGHT HEAD

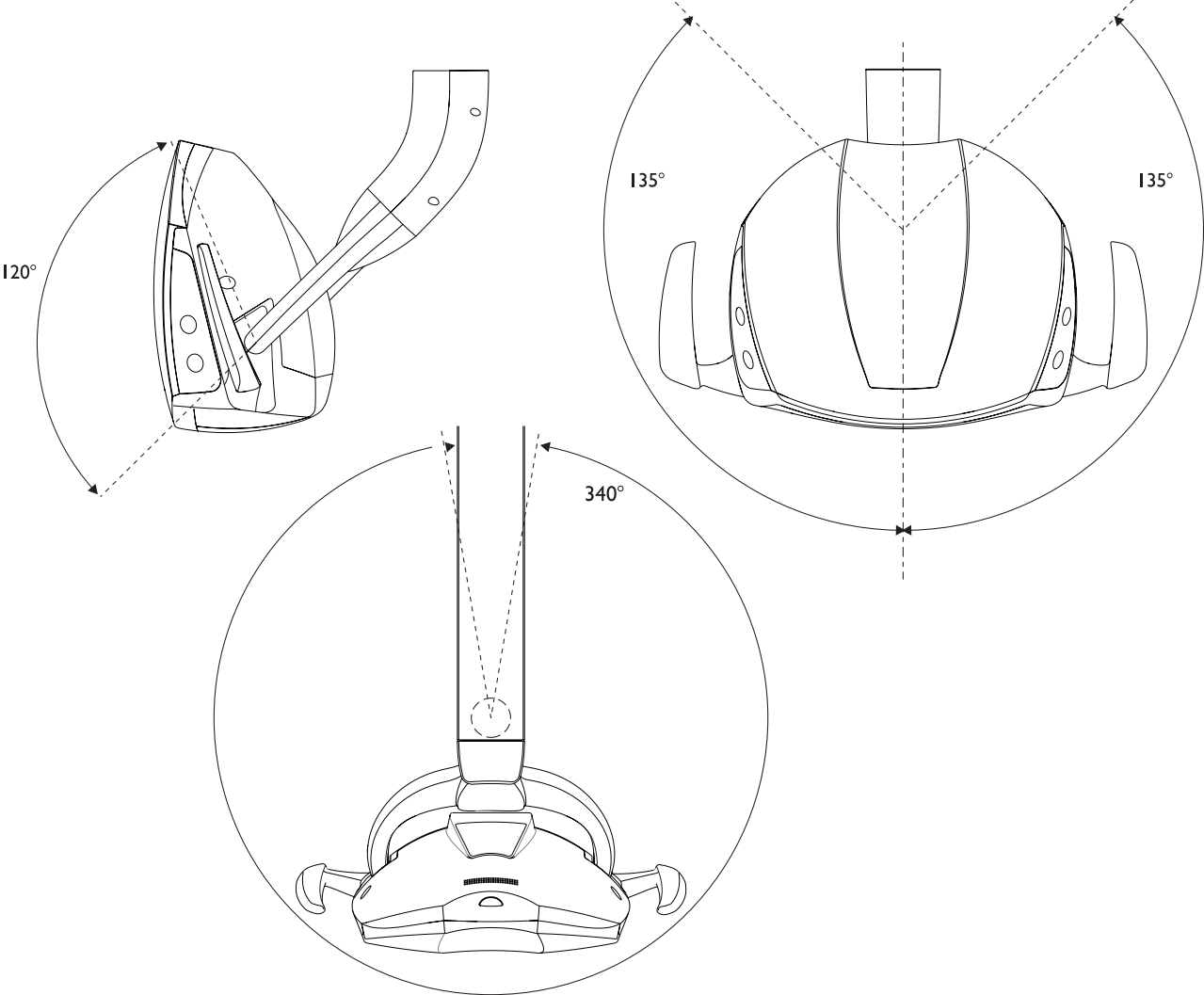

MAINTENANCE

BARRIER TECHNIQUE

Wherever possible, use disposable barriers and change them between patients. The barrier technique will ensure maximum long term durability of the surfaces and finishes of the equipment.

CLEANING

Dental equipment, categorized as noncritical devices with low risk of infection transmission, come into contact only with intact skin. Before applying disinfectant, clean the surfaces with a mild detergent and a clean cloth to remove unwanted dirt and debris.



CAUTION: Do not use powdered cleansers, scouring pads or abrasive scrubbers on any of the painted, plastic or metal surfaces of this dental unit. To remove dried-on material, use a soft bristled brush and a solution of mild detergent.

CHEMICAL DISINFECTION

Follow the instructions below carefully to ensure the longest life for your equipment:

1. Only use the acceptable disinfectants listed. Use of unacceptable products may void your warranty.
2. When applying chemicals with a spray bottle, **do not spray surfaces directly**. Instead, spray a cloth and then wipe the surfaces with the wet cloth.
3. When using chemical disinfectants, always pay strict attention to the manufacturer's disinfectant directions.
4. When using concentrated disinfectants, measure the concentrate carefully and mix according to package directions. **Disinfectant solutions at higher than recommended dilution ratios are extremely corrosive.**
5. Thoroughly wash all areas that have been exposed to disinfectant cleaners with mild soap and warm water at least once per day. This wash down will minimize the harmful effects of chemical disinfectant residues being allowed to accumulate on the equipment.

Conditionally Acceptable Disinfectants

- Phthalaldehyde
- Quarternary Ammonium
- Glutaraldehyde



CAUTION: These disinfectants will harm the surface finish of dental equipment and are not recommended.

Unacceptable:

- Strong Phenols/Phenol Alcohol combinations
- Sodium Hypochlorite/Household Bleach
- Sodium Bromide
- Strong Alcohol
- Household Cleaners (Dental Equipment Only)
- Citric Acids
- Iodophors
- Ammonium Chloride
- Accelerated Hydrogen (0.5%)

MAINTENANCE

REFLECTOR CLEANING

In the event that the reflector requires cleaning, follow the instructions below to avoid scratching the surface:

1. Saturate a clean, soft, lint-free cloth using mild detergent and warm distilled quality water.
2. Wipe the reflector gently with long horizontal or vertical strokes.
3. Use clean, dry, soft, lint-free cloth to dry the reflector.

SHIELD REPLACEMENT

The transparent shield is coated with a protective, anti-static and scratch resistant coating. Over time, the shield may still show the effects of disinfectants and cleaners. The shield may be removed by depressing the transparent button on the top surface of the light head and pulling the shield forward and away from the light head. Replace the shield by aligning both tabs at the bottom edge of the shield with the slots along the bottom edge of the front cover and then sliding the top tab until it engages in the top opening of the light head.

REMOVE SHIELD

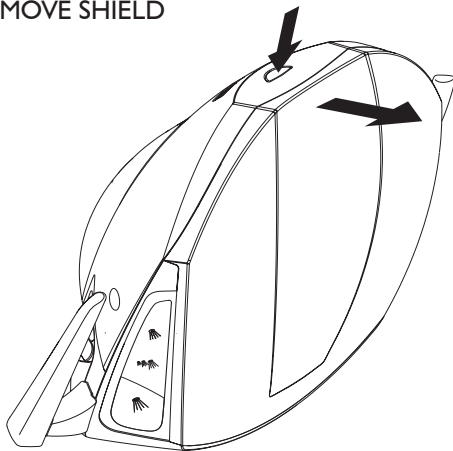

REPLACE SHIELD

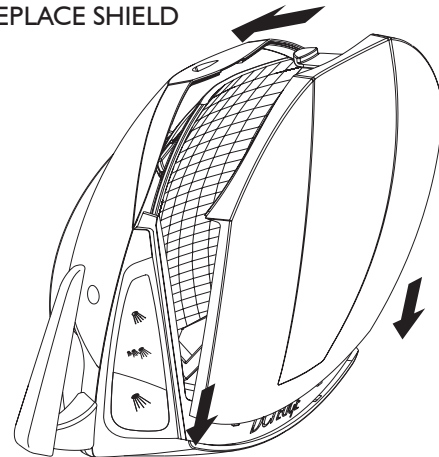

MAINTENANCE

TENSIONING

Adjust the tensioning of the 3 axes of rotation of the light head by tightening the set screw locations shown below:

- Vertical axis rotation 7/64 hex wrench
- Diagonal rotation of the light head 7/64 hex wrench
- Tilt angle of the light head 5/64 hex wrench

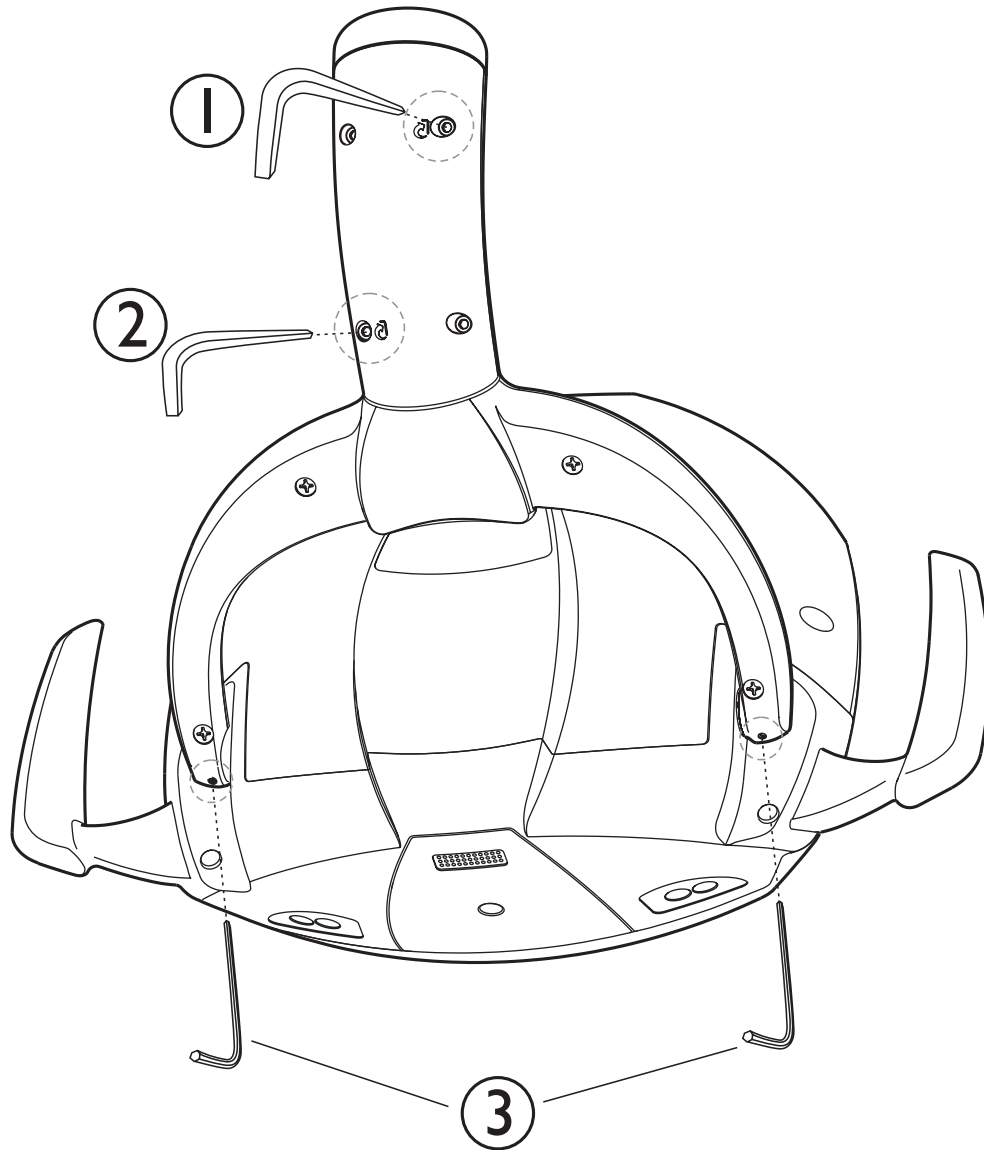

MAINTENANCE

FUSE AND BREAKERS

Under abnormal conditions, the circuit breaker or glass fuse interrupts the flow of electricity. If the circuit breaker trips, reset it by pushing the circuit breaker button or replacing the fuse as shown for the configurations below.

TRACK MOUNT

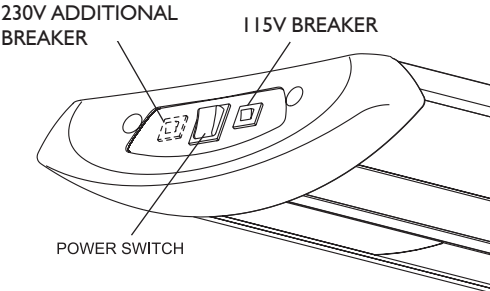

CAUTION: All fuses are labeled at point of use. Replace fuses only with type and rating as indicated.

POST MOUNT LIGHT

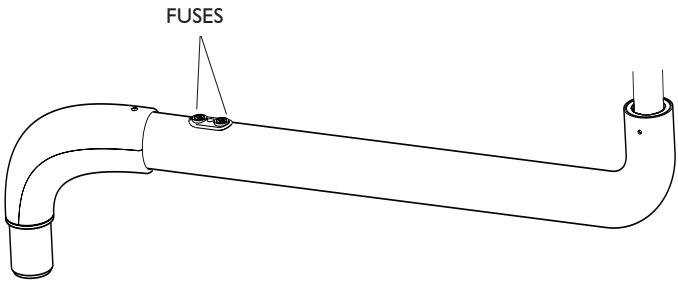

CEILING MOUNT

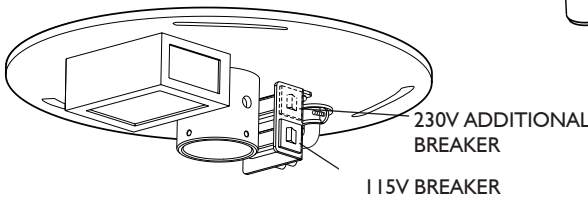

WALL MOUNT

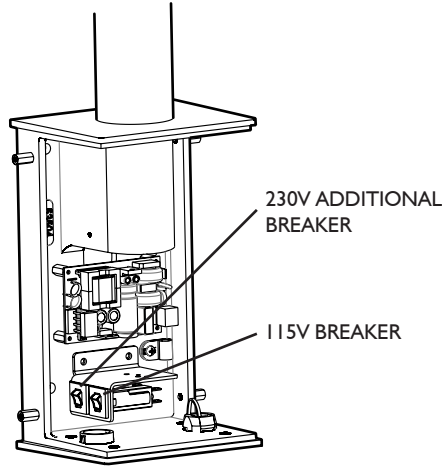

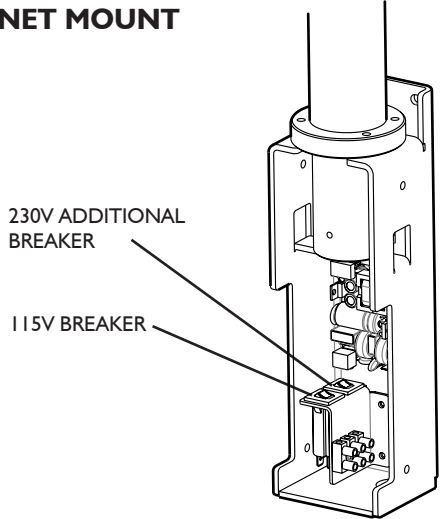

CABINET MOUNT

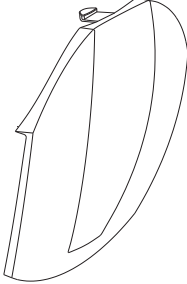
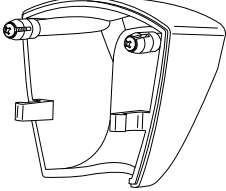

MAINTENANCE

REPLACEMENT COMPONENTS

PN	Description	Illustration
53066	Light Shield, DCI Edge	 A line drawing of a light shield component, which is a curved, semi-circular piece with a small tab at the top edge.
53961G	Assembly, End Cap, Post Mount/System Light, Light Gray	 A line drawing of an end cap assembly, showing a complex, multi-faceted component with several mounting points and a central opening.
53115G	Dress Cap, Drop Tube, Light Gray	 A line drawing of a dress cap, which is a small, circular component with a hexagonal hole in the center.

ELECTROMAGNETIC COMPATIBILITY

DEVICE COMPATIBILITY

ELECTRICAL MEDICAL

Electrical medical devices are subject to special EMC safety measurements and as a result the equipment must be installed according to the installation instruction manual.

PORTABLE ELECTRONIC DEVICES

Portable and mobile high frequency electronic communications equipment may interfere with electronic medical devices.

STATIC SENSITIVE DEVICES

Where labeled this equipment contains static sensitive devices that require special precautions when handling. At a minimum a grounded wrist strap that is connected to ground stud should be worn to reduce the possibility of damage to the light.

ACCESSORY USE

Using accessory devices not specified by DCI for use with their equipment may result in an increase of electromagnetic emissions and/or a decrease in electromagnetic immunity of the system.

INTERFERENCE FROM OTHER EQUIPMENT

If other equipment is used adjacent to or stacked with the DCI Edge equipment, the system must be observed to verify normal operation.

DCI EDGE LED OPERATORY LIGHT COMPLIANCE

This equipment has been tested and found to comply with the limits for medical devices in IEC 60601-1-2. These limits are designed to provide reasonable protection against harmful interference in a typical medical installation. In the event of interference, power the devices from separate mains supplies and/or increase the physical distance between devices. Contact Customer Service if you have any questions.

